

STRIKEARMS

AIRSOFT WEAPONS

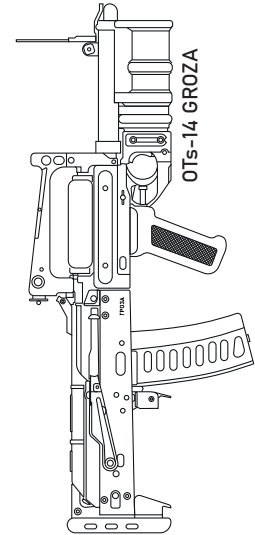

RUSSIAN-MADE AIRSOFT SPORTING EQUIPMENT

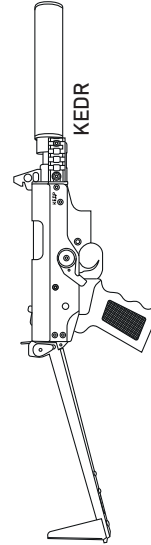
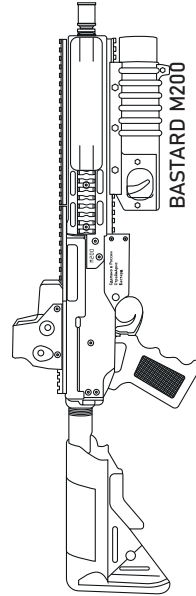
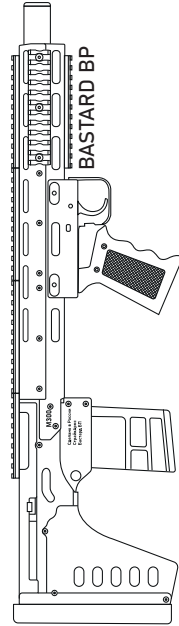
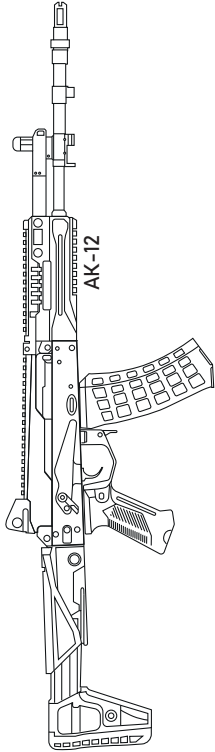

ABOUT STRIKEARMS

StrikeArms is a Russian engineering and manufacturing company founded in 2022.

Our core focus is the development and production of airsoft replicas, as well as training replicas of small arms and simulation devices.

We operate at the intersection of sport-tactical games, training programs, and applied tactical instruction, offering reliable and functional solutions for a wide range of users.

Background & Experience

The StrikeArms team has been active in the industry since 2016, starting with the design and production of launching devices for airsoft pyrotechnics under the StrikeArt brand.

Over the years, we have accumulated extensive hands-on experience in engineering design, material selection, equipment setup, and serial production.

In 2022, this expertise was scaled and formalized into a dedicated direction — StrikeArms — focused on developing proprietary airsoft platforms and training systems.

Partnership & Collaboration

StrikeArms works closely with specialized workshops, component manufacturers, and industry-focused projects.

Our collaboration model includes both long-term partnerships and project-based cooperation.

We value direct communication with users and partners, actively collecting feedback and integrating it into ongoing product development.

Core Principles

Reliability, functionality, and real-world applicability.

We develop products that perform with equal confidence in both gaming and training environments.

Contacts



+7 (991) 967-42-87
sales@strikearms.tech
strikearms.tech

СТРАЙКАРМС
СТРАЙКБОЛЬНОЕ
ОРУЖИЕ



AK КАЛАШНИКОВ
КОНЦЕРН

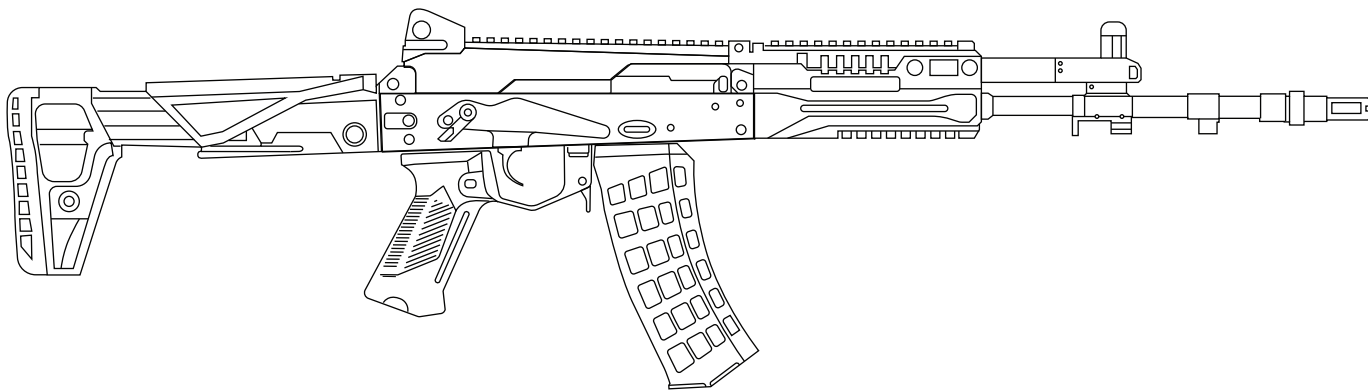

AK-12

- Joint Project with Kalashnikov Concern
- Original firearm components
- Unique CNC-milled aluminum gearbox
- Factory tuning from 425 fps



Versions:

AK-12K

6.03 mm inner barrel, 363 mm
Weight: 2.9 kg



AK-12CK

6.03 mm inner barrel, 280 mm
Weight: 2.7 kg



AK-12 Original Kalashnikov Concern components

Materials: steel, polymer, aluminum.

Gearbox: CNC aluminum, power from 425 fps.

Hop-Up: adjustable CNC aluminum hop-up unit with tracer illumination.

Magazine capacity: 110 BBs.

Shooting mode: safe / semi-auto / full-auto.

Inner Barrel: 6.03 mm, 455 mm.

Weight (base configuration): 3.0 kg.

AK ACCESSORIES

AK-12 MAGAZINE

Capacity magazine, 110 BBs.

Original Kalashnikov Concern body.

Materials: steel feed lips, reinforced polymer body.

Compatible with all AK-series airsoft replicas.

Weight: 240 g.



IRON SIGHT SET

Iron sight set for AK-12CK.

Materials: steel, aluminum.

Weight: 85 g.

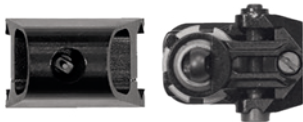

SUPPRESSORS

Lightweight hollow suppressor.

Available lengths: 120 mm / 170 mm / 200 mm / 240 mm.

Thread options: 14 mm CCW / 24 mm CW.

Material: aluminum.

120MM

Weight: 175 g.



170MM

Weight: 220 g.



200MM

Weight: 240 g.



240MM

Weight: 265 g.





STRIKEARMS
AIRSOFT WEAPONS



GROZA IN YOUR HANDS.
OTS-14 GROZA.

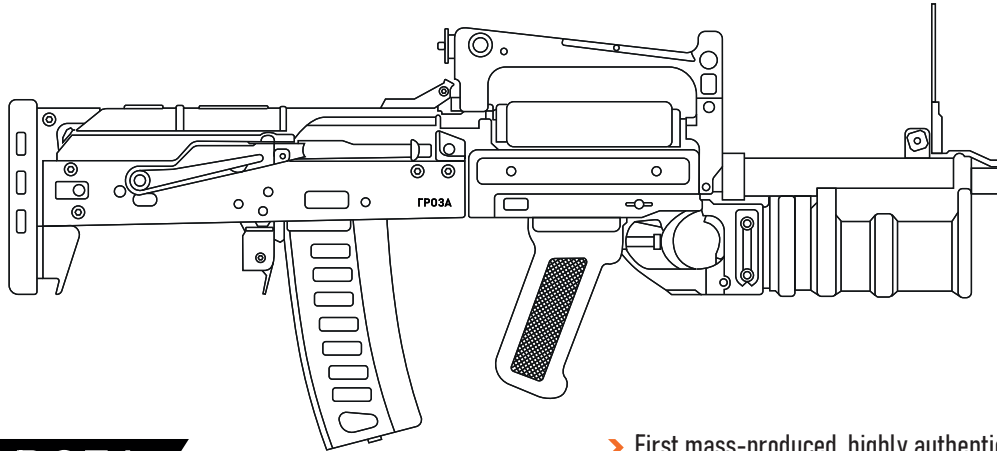

GROZA

- First mass-produced, highly authentic airsoft replica of the OTs-14 Groza
- Available in AEG and HPA configurations
- Hop-up unit with integrated tracer illumination
- Full accessory package included: grenade launcher, RIS rail, barrel extension, and suppressor

STRIKEARMS
AIRSOFT WEAPONS



GROZA IN YOUR HANDS.
OTS-14 GROZA.



GROZA AEG

CNC aluminum gearbox with full internal tuning package, including ARM-V electronics and 3 springs power rated at 390 fps, 425 fps and 470 fps.
Hop-up: adjustable CNC aluminum with tracer illumination.
Inner Barrel: 280 mm (flush with outer barrel, no additional modules installed).
Optional longer inner barrel available as a replacement.
Magazine capacity: 120 BBs.
Weight (base configuration): 2,5 kg.

MODIFICATIONS

WITH GRENADE LAUNCHER



WITH BARREL EXTENSION



WITH SUPPRESSOR



! YOU CAN BUY GROZA FULL COMPLETE: GROZA AEG, GRENADE LAUNCHER, BARREL EXTENSION, SUPPRESSOR AND RIS RAIL !

GROZA ACCESSORIES

SUPPRESSOR

Material: aluminum.
Weight: 440 g.



STANDARD CARRY HANDLE

Materials: steel, polymer.
Weight: 295 g.



RIS CARRY HANDLE

Materials: steel, polymer.
Weight: 295 g.



9×39 MAGAZINE

Additional 9×39 mm capacity magazine, 120 BBs.
Compatible with OTs-14 Groza and AK-series airsoft replicas.
Materials: steel, polymer.
Weight: 440 g.



GRENADE LAUNCHER

Compatible with gas and blank cartridges from various manufacturers.
Weight: 1,3 kg.



BARREL EXTENSION

Includes additional vertical grip and RIS rail.
Materials: steel, impact-resistant polymer.
Weight: 350 g.



RIS RAIL

Material: aluminum.
Installed in place of the carry handle.
Weight: 60 g.





STRIKEARMS
AIRSOFT WEAPONS



UNIQUE. RUSSIAN. STEEL.
THIS IS **KEDR**.

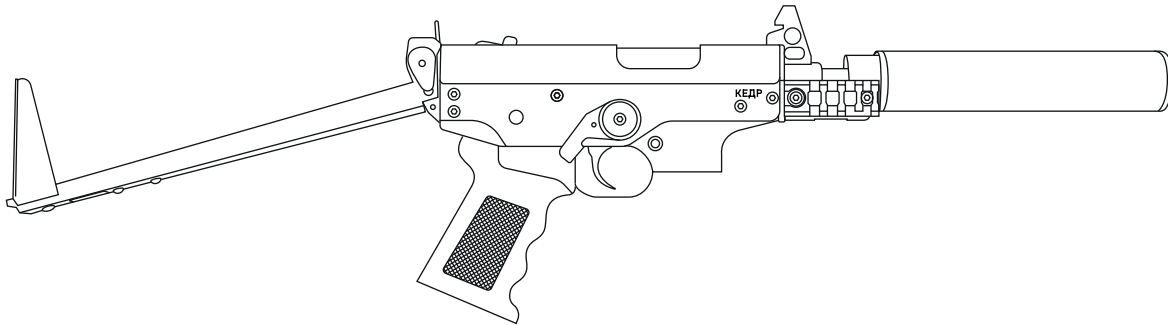

KEDR

- Lightweight steel submachine gun
- Folding stock
- Gearbox Ver3
- CNC-machined hop-up unit and nozzle (factory installed)
- Wide range of compatible accessories
- Competitive price point

STRIKEARMS
AIRSOFT WEAPONS



UNIQUE. RUSSIAN. STEEL.
THIS IS **KEDR**.



Alternative battery placement in stock

Battery housed in suppressor

KEDR-B

Suppressed version with extended inner barrel.

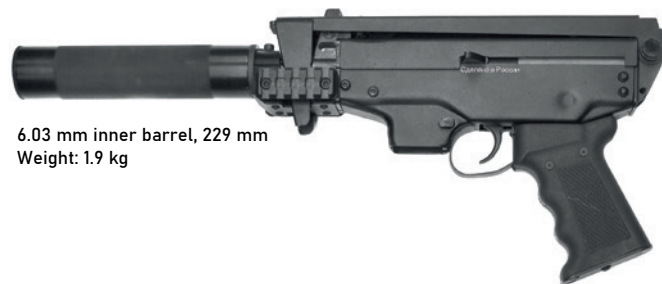

6.03 mm inner barrel, 229 mm
Weight: 1.9 kg

KEDR

Materials: steel, polymer, aluminum.

Gearbox: Ver 3, power 360 fps.

Inner Barrel: 6.03 mm, 110 mm.

Hop-Up: adjustable CNC aluminum hop-up.

Magazine capacity: 79 BBs.

Shooting mode: safe / full-auto.

Weight: 1.6 kg.

KEDR ACCESSORIES

KEDR MAGAZINE

Magazine capacity: 79 BBs.
Materials: steel, polymer.
Weight: 180 g.



KEDR SUPPRESSOR

Hollow suppressor designed to house battery.
Material: aluminum.
Weight: 130 g.



KEDR RIS TOP COVER

Receiver top cover with RIS rail.
Materials: steel cover, polyamide RIS rail.
Weight: 160 g.



ARM-V DESIRE V3 ELECTRONIC TRIGGER UNIT

Programmable electronic trigger unit.
Configured for semi-auto fire mode.
Designed for KEDR replicas.



RIS / M-LOK MOUNT

Mount for tactical foregrip with preserved folding stock function.
Includes extended screws and CNC-machined RIS rail.
Removable RIS rail conceals one M-LOK slot.
Materials: steel frame, polyacetal RIS rail.
Weight: 50 g.



KEDR KIT / KEDR-B KIT

 Unassembled kits without gearbox.

KEDR KIT

Includes: all body components, mounting hardware, adjustable CNC aluminum hop-up and nozzle, one magazine capacity 79 BBs.
Materials: steel, polymer.

KEDR-B KIT

HANDGUARD M100

M-LOK handguard for KEDR.
RIS rail length: 100 mm.
Materials: aluminum body, polymer RIS rails.
Weight: 185 g.

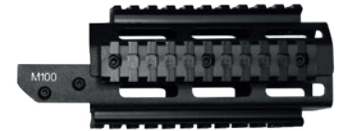



STRIKEARMS
AIRSOFT WEAPONS



WHERE UNIQUENESS MEETS PERFORMANCE.
BASTARD — THE RUSSIAN M-PLATFORM.

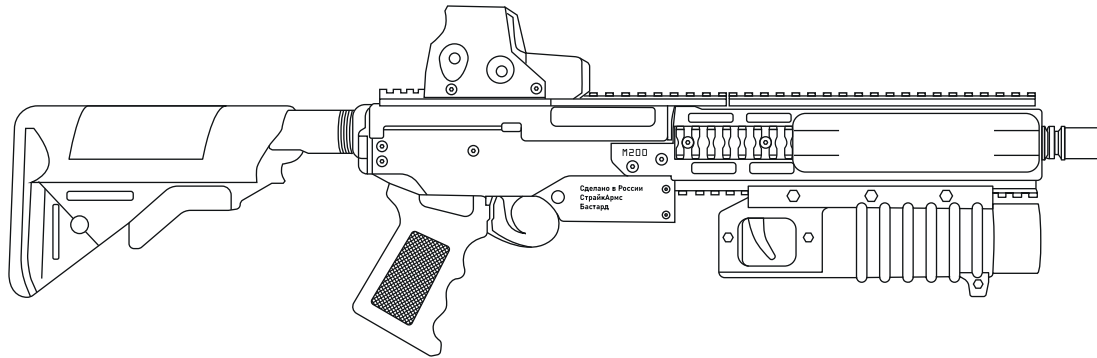

BASTARD

BASTARD BP

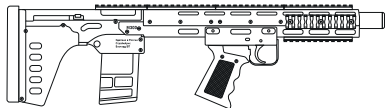

- Best features of the M-series in a steel body
- M-LOK and RIS interfaces for full accessory compatibility
- Gearbox Ver3
- CNC-machined hop-up unit and nozzle installed as standard
- Exclusive bullpup configuration based on the Bastard platform
- Compatible with M-series accessories

STRIKEARMS
AIRSOFT WEAPONS



WHERE UNIQUENESS MEETS PERFORMANCE.
BASTARD — THE RUSSIAN M-PLATFORM.



M100

6.03 mm inner barrel, 110 mm
Weight: 1.8 kg



M200-363

6.03 mm inner barrel, 363 mm
Weight: 2.2 kg



M300-363

6.03 mm inner barrel, 363 mm
Weight: 2.4 kg



M300

6.03 mm inner barrel, 509 mm
Weight: 2.6 kg



BASTARD M200

Materials: steel, polymer, aluminum.

Gearbox: Ver3, power 360 fps.

Inner Barrel: 6.03 mm, 229 mm.

Hop-Up: adjustable CNC aluminum.

Magazine capacity: 120 BBs.

Shooting mode: safe / semi-auto / full-auto.

Weight (base configuration): 2.1 kg.

FOR THOSE WHO VALUE UNCONVENTIONAL FORM.
BASTARD BP (BULLPUP).

BASTARD BP

Inner Barrel: 6.03 mm, 363 mm
Weight: 2.2 kg



BASTARD BP WITH SUPPRESSOR

Materials: steel, polymer, aluminum.
Gearbox: Ver3, power 360 fps.
Inner Barrel: 6.03 mm, 509 mm
Hop-Up: adjustable CNC aluminum.
Magazine capacity: 120 BBs.
Shooting mode: safe / semi-auto / full-auto.
Weight (base configuration): 2.5 kg.

BASTARD ACCESSORIES



SUPPRESSOR

Universal hollow suppressor for battery housing.
Designed for 14 mm CCW threaded barrels.
Material: aluminum.
Weight: 140 g.



BUFFER TUBE

Buffer tube for M-series stocks.
Material: aluminum.
Weight: 135 g.



SINGLE-POINT SLING MOUNT

Single-point sling adapter for M-series replicas.
Material: steel.
Weight: 20 g.

HANDGUARD M100

RIS rail length: 100 mm.
Materials: steel, polyamide.
Weight: 185 g.



HANDGUARD M200

RIS rail length: 200 mm.
Materials: steel, polyamide.
Weight: 295 g.



HANDGUARD M300

RIS rail length: 300 mm.
Materials: steel, polyamide.
Weight: 400 g.



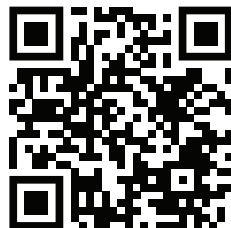

STRIKEARMS
AIRSOFT WEAPONS



**RUSSIAN-MADE AIRSOFT
SPORTING EQUIPMENT**

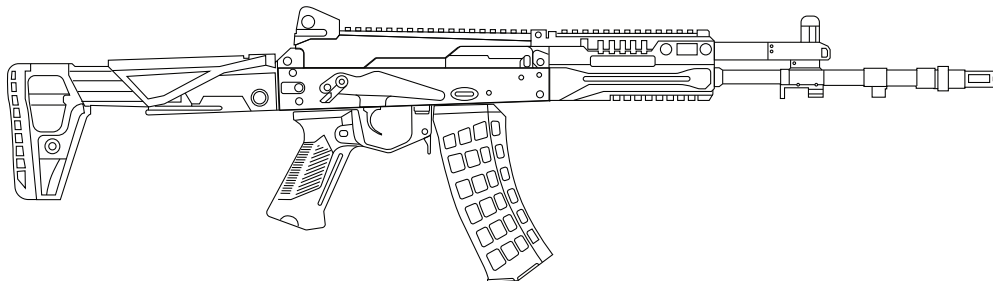

+7 (991) 967-42-87
sales@strikearms.tech
strikearms.tech